

HIGH POWER LASER MODULE WITH FIBER OUTPUT

ALC-980-50000-FM200.22-Quinta

Features

- Compact size
- Detachable 200 μ m SMA-fiber
- Thermistor
- Power monitor
- Fiber sensor

Applications

- Medical
- Laser pumping



Specifications

Optical Parameters	Units	
Center Wavelength	nm	980
Wavelength Tolerance	nm	± 5
Spectral Width (FWHM)	nm	3
Wavelength Temp. Coefficient	nm/ $^{\circ}$ C	0.38
Output Power	W	50
Operating Current	A	12
Operating Voltage	V	<12
Threshold Current	A	0.55

Fiber Parameters		
Fiber Core Diameter	μ m	200
Numerical Aperture		0.22
Fiber Connector		SMA-905

Pin-Out

1. Red pointer (+)
2. Red pointer (-)
3. Power monitor (+)
4. Laser Diode Anode
5. Laser Diode Anode
6. Not connected
7. Not connected
8. Not connected
9. Thermistor
10. Thermistor
11. Not connected
12. Not connected
13. Power monitor (-)
14. Laser Diode Cathode
15. Laser Diode Cathode
16. Not connected
17. Fiber sensor
18. Fiber sensor
19. Fiber sensor
20. Fiber sensor

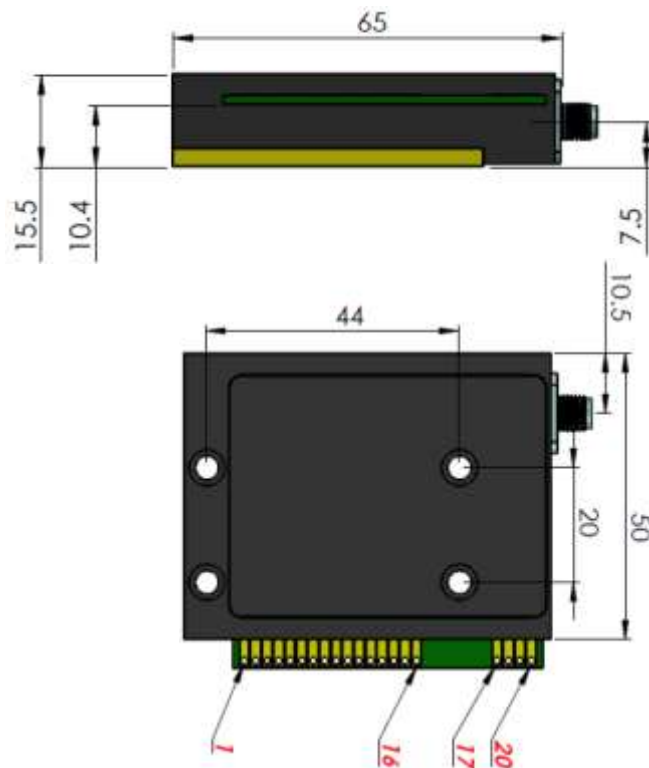

These components do not comply with the Federal Regulations (21 CFR Subchapter 1) as administered by the Center for Devices and Radiological health.

Purchaser acknowledges that his/her products must comply with these regulations before they can be sold.

Akela laser Corporation reserves right to change any specifications.

AKELA Laser Corporation

1095 Cranbury South River Road, Suite 14, Jamesburg, NJ 08831, USA

Phone: (732) 305-7105

e-mail: info@AKELALaser.com

web: www.AKELALaser.com