

HIGH POWER LASER MODULE WITH FIBER OUTPUT

ALC-808-25000-FM200.22-TRIO

Features

- Detachable 200 μ m SMA-fiber
- Thermistor
- Power monitor
- Compact footprint 35 mm x 38 mm
- Red pilot laser

Applications

- Medical
- Solid State Laser Pumping



Specifications

Optical Parameters	Units	
Center Wavelength	nm	808
Wavelength Tolerance	nm	± 5
Spectral Width (FWHM)	nm	5
Wavelength Temp. Coefficient	nm/ $^{\circ}$ C	0.3
Output Power	W	25
Operating Current	A	10
Operating Voltage	V	<7.2
Threshold Current	A	1.1

Fiber Parameters		
Fiber Core Diameter	μ m	200
Numerical Aperture		0.22
Fiber Connector		SMA-905

Pin-Out

1. Red Laser Anode
2. Red Laser Cathode
3. Laser Diode Anode
4. Thermistor
5. Thermistor
6. Power monitor (+)
7. Power monitor (-)
8. Laser Diode Cathode

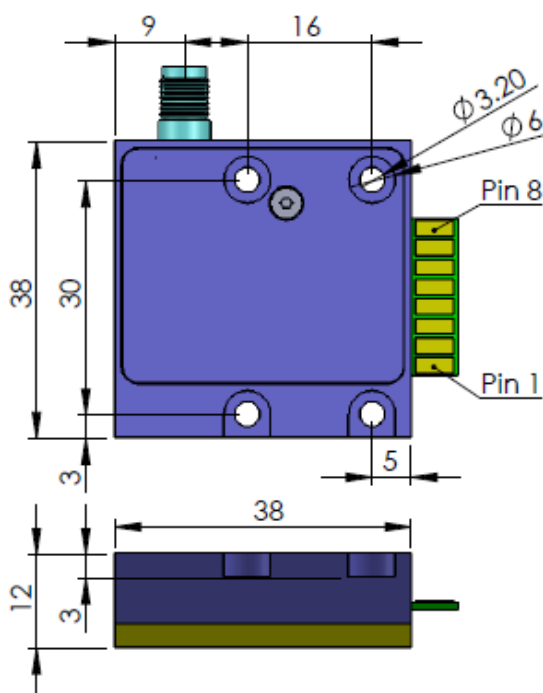

These components do not comply with the Federal Regulations (21 CFR Subchapter 1) as administered by the Center for Devices and Radiological health.

Purchaser acknowledges that his/her products must comply with these regulations before they can be sold.

Akela laser Corporation reserves right to change any specifications.

AKELA Laser Corporation

1095 Cranbury South River Road, Suite 14, Jamesburg, NJ 08831, USA

Phone: (732) 305-7105

e-mail: info@AKELALaser.com

web: www.AKELALaser.com