

HIGH POWER DIODE LASER MODULE WITH FIBER OUTPUT

ALC-515-0080-FM200.22

Features

- Compact size
- Detachable 200 μ m SMA-fiber
- Thermistor
- Power monitor

Applications

- Medical
- Solid State Laser Pumping

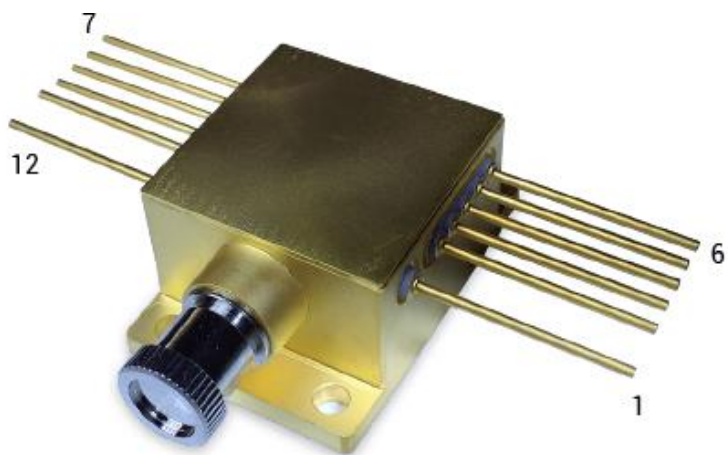

Specifications

Optical Parameters	Units	
Center Wavelength	nm	515
Wavelength Tolerance	nm	± 5
Spectral Width (FWHM)	nm	2.3
Wavelength Temp. Coefficient	nm/ $^{\circ}$ C	0.04
Output Power	mW	>80
Operating Current	mA	250
Operating Voltage	V	<7.0
Threshold Current	mA	60

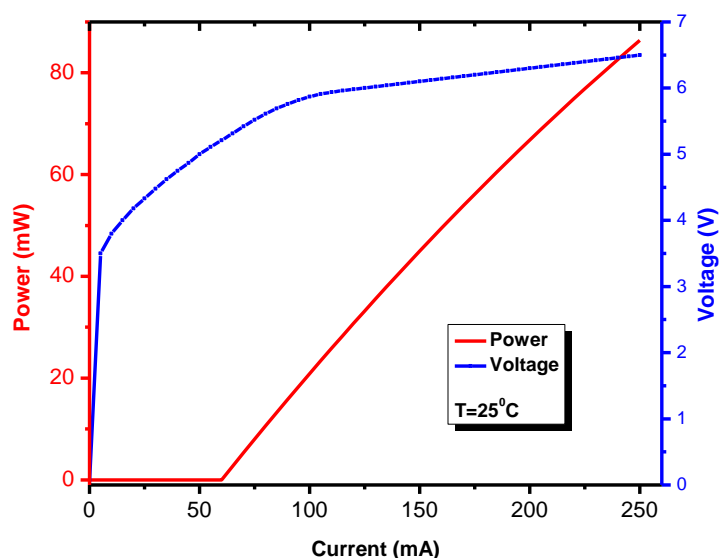

Fiber Parameters		
Fiber Core Diameter	μ m	200
Numerical Aperture		0.22
Fiber Connector		SMA-905

Pin-Out

1. TEC (+)
2. Thermistor
3. Not connected
4. Laser Diode Anode
5. Laser Diode Anode
6. Power monitor (+)
7. Power monitor (-)
8. Laser Diode Cathode
9. Laser Diode Cathode
10. Not connected
11. Thermistor
12. TEC (-)

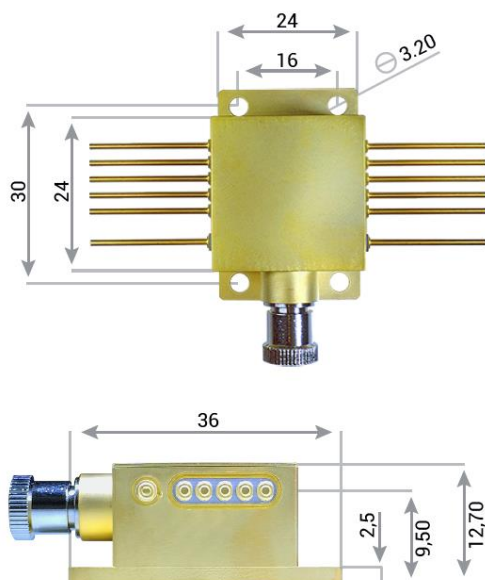

These components do not comply with the Federal Regulations (21 CFR Subchapter 1) as administered by the Center for Devices and Radiological health. Purchaser acknowledges that his/her products must comply with these regulations before they can be sold. Akela laser Corporation reserves right to change any specifications.